

9230 / 9260

HERZ Thermostatic Head

9230
9260



O11
EN 215
tested and registered

certificated products
1 9230 06
1 9260 06

- 1 **9230 06 Radiator thermostat with hydrosensor (liquid filled)**
with shutoff (0) position, adjustable frost release, limitation and locking of selected temperature range, handwheel white.
- 1 **9260 06 Radiator thermostat with hydrosensor (liquid filled)**
with automatic frost release, limitation and locking of selected temperature range, handwheel white.

Models

9230

9260

- 1 **9230 59 Radiator thermostat with grip ring**
The grip ring on the handwheel permits exact setting of the desired comfort temperature, even in cases of physical disability.

With "0" position, adjustable frost release, with limitation and locking of selected temperature range, handwheel white.

Special model

Set temperature range **9230:** 6-30 °C
 9260: 6-28 °C
Frost safety temperature 6 °C

The HERZ thermostat is maintenance-free.

Operating Data

Suitable for mounting on all HERZ thermostatic valves.

For article numbers, dimensions and form of delivery of HERZ valves see the respective product standard sheets.

Field of Application

The HERZ thermostat serves as a room temperature sensing and control unit. The change in volume of the liquid contained in the hydrosensor actuates the valve spindle.

Mode of Operation

The attractive design of the HERZ thermostat was developed in cooperation with "Porsche Design GmbH", Ferdinand A. Porsche, A-5700 Zell am See.

Design

We reserve the right to make modifications necessitated by technological progress.

By setting the scale marks opposite the pointer it is possible to achieve the following temperatures in the room (approx.). Deviations of a few degrees (K) are possible according to the mode of installation and the design of the heating system.

Mark	*	1	2	3	<input checked="" type="checkbox"/>	4	5	6
~ °C	6	10	13	17.5	20	22	25	28

Thermostat **9230**: Turning anti-clockwise to the maximum position (preset by manufacturer) corresponds to approx. 30 °C.
 Thermostat **9260**: Scale mark "6" corresponds to approx. 28 °C.

Adjustment Options

Handwheel Scale

Maximum Adjustment

The comfort point corresponds to a room temperature of approx. 20 °C. This means optimum heating comfort and energy saving.

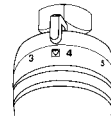

Comfort Point



The position "*" allows the valve to open automatically at an ambient temperature of approx. 6 °C thus preventing the system from freezing.

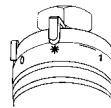

Frost Release



In position "0" the thermostatic valve is shut off and the frost release is turned off. Thermostatic function remains active.

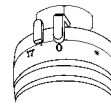

**Turnoff
Thermostat 9230**

The preset stop limit is shown by a point mark and corresponds to the entire turning range.

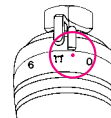

**Pre-Setting by
Manufacturer**

After the end of the heating period, open thermostat completely by turning anti-clockwise to prevent dirt deposits at the valve seat.

Summer Position

For protection against theft a clip is available which is fitted over the fastening nut.

Theft Protection

- 1 **6640 00** HERZ Universal key, for opening theft protection
- 1 **6807 90** HERZ TS-90 assembly key
- 1 **9551 00** Limiting pins for limiting and locking the set value range
- 1 **9552 03** Theft protection (snap clips), opening by means of key 1 6640 00
- 1 **9553 44** Cover sleeve for thermostat fastening nut

Accessories

1. Unscrew cap or handwheel from the lower part of the thermostatic valve.
2. Place thermostat head on the lower part of the valve in "completely open" position (as preset by manufacturer) in such a way that the twist locking ring clicks in and the pointer is perfectly visible.
3. Tighten union nut moderately with 30 mm key.
4. Test operation by turning the handwheel.

Installation

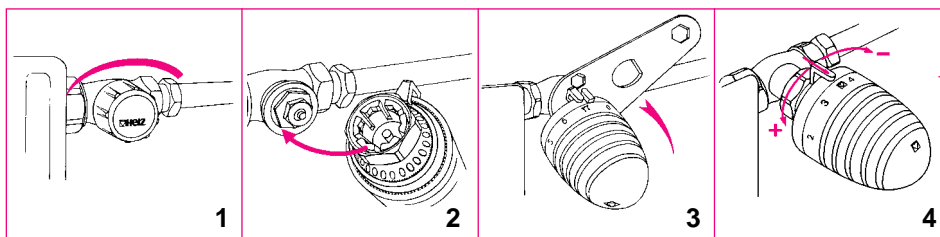

Under no circumstances should the HERZ thermostatic head be exposed to direct sunlight or to the effects of equipment emitting relevant quantities of heat, e.g. TV sets. If the radiator is covered by curtains or panelling this will lead to the formation of a heat accumulation zone in which the thermostat cannot sense the room temperature properly and consequently is not in a position to control it. In such cases, use the HERZ thermostat with remote sensor or the HERZ thermostat with remote adjustment.

Important for Installation

Adjustments for Limitation and Locking of Set Temperature Range

Limitations

Personal Comfort Point Adjustment

By changing the position of the click-in limiting pin ring the personal comfort point can be adjusted to a maximum or a minimum limit. The full temperature range is provided by manufacturer.

Procedure

- Turn handwheel to desired position (fig. 1).
- Release limiting pin ring in the direction of valve (one notch) and turn in such a way that the limiting pin is positioned to the left (lower limit) or to the right (upper limit) of the pointer (fig. 2, 3).
- Click-in the adjusted limiting pin ring (fig. 4).
- The thermostat head can now be turned to the desired position or from there to the maximum position.

This comfort point adjustment can be changed or cancelled at any time.

The pre-setting by manufacturer for the limit is shown by a round mark and corresponds to the complete temperature range.

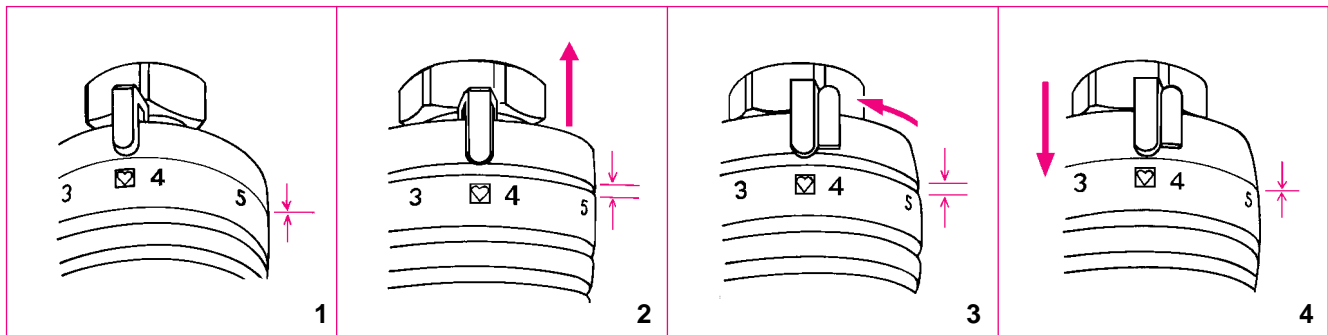

Concealed Limitation or Locking

By placing one or two limiting pins a limitation or locking of the temperature range can be achieved, invisible to and unchangeable by anybody unauthorised.

The limiting pins are available as accessories. Set: Article no. 1 9551 00.

Procedure

The lower side of the thermostatic head has a circle of holes in the base for the limiting pins.

- Set the handwheel of the thermostatic head to the desired limitation or locking position.
- Between positions “*” and “1” of the handwheel scale a crossline can be found which marks the point where the limiting pins are to be placed. The procedure is the same as for “Limitations” (see above).

- Lower limit:
Insert pin in hole aligning with the left end of the line.
- Upper limit:
Insert pin aligning with right end of the line.
- Locking to one setting:
Insert one pin at each end of the line.

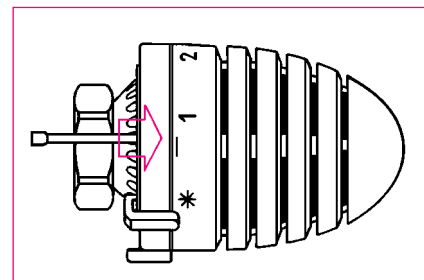

- The limit pins must be inserted fully. They may be removed with an appropriate tool (flat pliers etc.).